

F00VC01333 Injector Valve Assembly Technical File



FO0VC01333 Injector Valve Assembly Technical File**Content**

1. F00VC01333 Injector Valve Assembly's Introduction	2
1.1.F00VC01333 Injector Valve Assembly's Basic Information	2
1.2.F00VC01333 Injector Valve Assembly's Application Information for Injectors.....	2
1.3.F00VC01333 Injector Valve Assembly's Specifications and Dimensions Parameters	4
1.4.F00VC01333 Injector Valve Assembly's Quality Control.....	4
1.5.F00VC01333 Injector Valve Assembly's Customized Service	4
1.6.F00VC01333 Injector Valve Assembly's Packing List.....	5
1.7.F00VC01333 Injector Valve Assembly's Warranty Instructions	5
1.8.F00VC01333 Injector Valve Assembly's Manufacturer	6
2.F00VC01333 Injector Valve Assembly Technical Support	6
2.1.F00VC01333 Injector Valve Assembly's Installation Precautions	6
2.2.F00VC01333 Injector Valve Assembly Replacement Conditions	7
2.3.F00VC01333 Valve assembly Technical Support Obtaining Methods.....	8
3.F00VC01333 Valve Assembly's Purchase and Delivery.	8
3.1.F00VC01333 Valve Assembly Purchase Payment Terms	8
3.2.F00VC01333 Valve assembly's Main Sales Market.....	8
3.3.F00VC01333 Valve assembly's Declaration Requirements	8
3.4.F00VC01333 Valve Assembly's Shipping Ways	8
3.5.F00VC01333 Valve Assembly's Lead Time	8
3.6.F00VC01333 Valve Assembly's Logistics Time for Destination Out of China's Areas.....	9
3.7.F00VC01333 Valve Assembly's Packing	9
4.F00VC01333 Valve Assembly's Storage Standard	10
5. Company Information.....	11
5.1. Company Introduction	11
5.2. Sales-men's Contact Information	11
6. Copyright Statement.....	12

F00VC01333 Injector Valve Assembly Technical File

1. F00VC01333 Injector Valve Assembly's Introduction

1.1.F00VC01333 Injector Valve Assembly's Basic Information

Title	China made brand new fuel injector valve assembly F00VC01333
SKU1	G1L10F00VC01333/L10000B2BC01333

1.2.F00VC01333 Injector Valve Assembly's Application Information for Injectors

(1) F00VC01333 Injector Valve Assembly's Car Model Matching Information

Injector Part Number	Car Number	OE Number	OE Number	OE Number				
0 445 110 218	CHRYSLER	05142 811AA	5142 811AA					
	JEEP	05142 811AA	5142811A A					
	VM (MOTORI /STABILIMENTI MEC.)	15 06 2048F						
0 445 110 286	VM (MOTORI /STABILIMENTI MEC.)	15 06 2055F	50 60 1330					

(2) F00VC01333 Injector Valve Assembly's Application for Injectors' Part Number

Injector Series	Injector Part Number	System Pressure	Re-manufactured Part Number	System Pressure	Universal Number	System Pressure	Universal Number	System Pressure	Universal Number
CRI2.1 (1600 BAR)	0 445 110 218	1600	0 986 435 128	1600					
			F 00E 200 440						
CRI2.1 (1600 BAR)	0 445 110 286	1600	0 986 435 266	1600					

(3) F00VC01333 Injector Assembly Part Number Common Writing

F00VC01333, F00VC01333, F 00V C01 333, F 00V C01 333, F00V C01 333, F00V C01 333, F00VC01333, F00VC01333, F 00V C01333, F 00V C01333, F 00V C01333, F 00VC01333, F 00VC01333, F00V C01333, F00V C01333

1.3.F00VC01333 Injector Valve Assembly's Specifications and Dimensions Parameters

Valve Assembly Size: 13 cm*2 cm *2 cm

Valve Assembly Box Size: 14 cm *3 cm *3 cm

Valve Assembly Packing Size: 31 cm *12 cm

Valve Assembly Net Weight: 0.03kg

Valve Assembly Gross Weight: 0.03kg

Valve Assembly Quality: China Made Brand New Injector Valve Assembly

Valve Assembly MOQ: 4 PCS

1.4.F00VC01333 Injector Valve Assembly's Quality Control

(1) Valve Assembly Testing

All parts of the injector valve assembly are subjected to precision testing, high temperature testing, low temperature testing, withstand pressure testing, leakage testing, durability testing, and various working conditions testing.

(2) Injector Valve Assembly Inspection







The factory inspection of the injector valve assembly is undergone full inspection, random inspection, and batch inspection three inspections. Different brands of test benches are used to test the same injector valve assembly for a total of no less than three times for factory inspection, and the fuel injector installation testing environment are progressed in dust-free workshop.

(3) Injector Valve Assembly Installation

When matching the valve cap and valve stem, Shumatt strictly complies with the standard of valve cap and valve stem clearance technical indicators to ensure that each valve assembly meets the factory standards and use standards.

1.5.F00VC01333 Injector Valve Assembly's Customized Service

(1) Valve Assembly's Customized Service: Meet the customized needs of OEM manufacturers for shell lettering, logo engraving, injector internal packaging, injector external packaging and labels customized, etc.

		
Valve Cap Color Customized 1000 pieces (White color is optional)	Valve Cap Color Customized 1000 pieces (Purple and red color are optional)	Valve Cap Groove Customized
		
Valve Cap Lettering、Valve Cap logo Engraving、Valve Cap QR Code Engraving	Valve Assembly Box (Square is optional)	Valve Assembly Box (Cylindrical is optional)

		/
Valve Assembly Bag	Valve Assembly Label 7cm*5cm	/

(2) Valve Assembly's Customized Service Requirements:

Customized valve assembly box are no less than **100** pieces.

Customized valve assembly groove no less than **100** pieces.

The purchased of customized valve assembly are no less than **1000** pieces.

The purchased of customized valve cap engraving contents are no less than **1000** pieces.





The purchased of customized valve colors are no less than between **1000 -10000** pieces.

Customized products involve the need of specify logo, the OEM manufacturer needs to provide trademark authorization and the sample of logo image file.

▲ Once the customized injector valve assembly is sold, it can not be returned or exchanged if there is no quality problems.

1.6.F00VC01333 Injector Valve Assembly's Packing List

(1) Valve Assembly's spare parts list

Serial Number	1	2	3
Image			
Name	Injector Valve Assembly	Valve Assembly Anti-rust Paper	Valve Assembly Box (Square is optional)
Description	Valve Assembly Part Number F00VC01333	Prevent the valve assembly from rusting	Protect the valve assembly from being damaged by colliding
Serial Number	4	5	
Image			/
Name	Valve Assembly Box (Cylindrical is optional)	VCI Anti-rust Bag	/
Description	Protect the valve assembly from being damaged by colliding	Prevent the valve assembly from rusting	/

▲ Minors are prohibited from using the injector valve assembly, valve assembly anti-rust paper, valve assembly box, and VCI anti-rust bag to avoid personal injury.

▲ The valve assembly box is recyclable and can be reused.

▲ VCI anti-rust bag is non-degradable material, please dispose of it properly after use.

1.7.F00VC01333 Injector Valve Assembly's Warranty Instructions

(1) . Valve Assembly Warranty Conditions and Instructions

It is necessary to provide pictures, videos, or test reports detected by the injector valve assembly inspection equipment when the valve assembly is abnormal during use as evidence to feed back to the

salesman.

Abnormal conditions are properly explained such as: 1.Smoke, 2. Engine shake, 3. Difficulty starting the engine, 4. Engine noise, 5. oil leakage etc.

(2) . Valve Assembly Warranty Coverage

Within 15 days after customer receives the **F00VC01333** injector valve assembly, if there is a performance failure and the product has no appearance damage, customer can choose to replace it or repair it;

If the **F00VC01333** injector valve assembly has performance problems during the warranty period (3 months), and it is confirmed that it is product's problems after testing, you can contact our salesmen to replace the same model or a reworked product with the same performance for free;

If the injector house has obvious scratches, it can only be repaired and it will be returned as it is if the product is confirmed to be fault-free.

(3) . Injector Valve Assembly Out of Warranty Coverage

The warranty period has expired.

Injector valve assembly failure caused by high temperature, high pressure, humidity, rain and snow, saline-alkali land, earthquake, and used in abnormal environment.

Injector valve assembly damage caused by man-made reasons (throwing, strong magnetic field magnetization, set fire).

Injector valve assembly failure or injector damage caused by non-injector design, technology, manufacturing, quality and other issues.

Injector valve assembly failure due to system pressure exceeding system approved pressure.

Injector valve assembly failure caused by system voltage exceeding approved voltage.

Injector valve assembly failure caused by impurities (water, lead, aluminum powder, iron powder, sulfide) in the system fuel exceeding the standard requirements.

Injector valve assembly failure caused by not installing according to the tightening torque specified in the vehicle engine maintenance manual (the tightening torque is too large or too small).

Injector valve assembly failure caused by not following the installation angle specified in the injector maintenance manual.

Injector valve assembly failure caused by not following the cleaning requirements specified in the injector maintenance manual.

Injector valve assembly failure caused by failure to replace consumable parts as specified in the injector maintenance manual.

1.8.F00VC01333 Injector Valve Assembly's Manufacturer

Injector Valve Assembly's Manufacturer: Shenzhen Shumatt Technology Co.,Ltd

2.F00VC01333 Injector Valve Assembly Technical Support

2.1.F00VC01333 Injector Valve Assembly's Installation Precautions

- (1) **Clean the injector valve assembly in an ultrasonic cleaner for 3-5 minutes before installation, so as to make the stains, dust, rust-proof oil oxides**, paraffin base, naphthenic base, intermediate base, salt, lead naphthenate, zinc naphthenate, sodium petroleum sulfonate, barium petroleum sulfonate, calcium petroleum sulfonate, tallow diamine trioleate, rosin amine on the surface of the valve assembly fall off.
- (2) Use compressed air to clean the cleaning fluid attached to the surface of the valve assembly after cleaning, and clean it up to the standard of use, as below
- (3) When installing the valve stem, make sure that the valve stem and the bonnet must ensure that the valve stem can move smoothly in it. as below

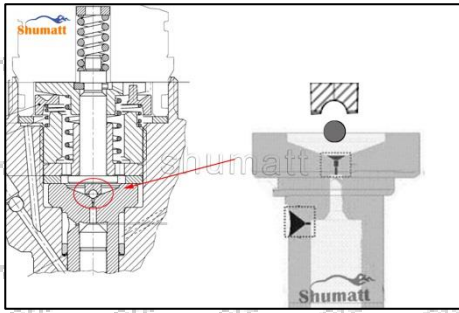

(4) When installing the valve stem, make sure that the valve stem and the bonnet must ensure that the valve stem can move smoothly in it, as below

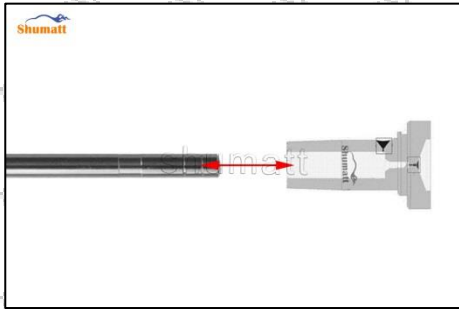

If the injector steel ball and the ball seat are not installed in accordance with the standard, it may cause serious damage to the injector valve assembly

2.2.F00VC01333 Injector Valve Assembly Replacement Conditions

(1) Valve Cap

Under the microscope, magnify 20 times to check that the oil inlet hole of the valve cap and the oil return hole of the bonnet are not worn, grooved, scratched, damaged, rusted or dented.

<p>Valve cap inlet hole location</p>	<p>Valve cap return hole location</p>	<p>The oil inlet and oil return holes of the valve cap are free of wear, grooves, scratches, damage, rust, dents, and do not need to be replaced</p>
<p>The Valve cap oil hole is recessed and needs to be replaced</p>	<p>The valve cap oil hole is worn and needs to be replaced</p>	<p>The valve cap oil hole is punched and needs to be replaced</p>



▲ The wear of the top oil return hole causes the oil return to be too large and the leaking injector cannot inject oil

▲ The side inlet hole is blocked causing the injector to establish the pressure chamber and the injector to function normally

▲ **Wear of the cap cavity can cause the injector to work properly when the injector is badly delayed.**

(2) Valve Rod

Microscope amplification 20 times, check the valve rod for wear, not smooth surface color, rust

		
The valve stem is worn out and needs to be replaced	The valve stem surface is not smooth and colorless, and it needs to be replaced	The valve stem is rusty and needs to be replaced

▲ **The excessive clearance between the stem wear and the housing and between the cap causes an injector delay**

▲ **The valve stem lag will cause the injector to start the solenoid to start, and the oil needle can not return quickly after the nozzle is opened**

▲ **Check the injector components before replacing the injector valve assembly according following the injector service manual to avoid further damage to the injector valve assembly.**

2.3.F00VC01333 Valve assembly Technical Support Obtaining Methods

(1) Valve Assembly Technical File, visit <http://shumatt.com> to get the technical file

(2) **Injector Technical Videos**

Facebook: Visit <https://www.facebook.com/hison.li> constantly follow can get more information.

YouTube: https://www.youtube.com/channel/UcByvYBx7VjV_mAfxh_Hu-aw to get the technical videos, constantly follow can get more information.

Shumatt: Visit <http://shumatt.com> to get the technical videos.

(3) Valve Assembly Information Query Software

TruckBook Parts EPC APP, Android/Apple App Store download and install, visit <http://shumatt.com> to get the download and installation tutorial

(4) Search The valve assembly test data through TruckBook Parts EPC APP.

3.F00VC01333 Valve Assembly’s Purchase and Delivery.

3.1.F00VC01333 Valve Assembly Purchase Payment Terms

Payment Terms: T/T, PayPal, Alipay, WeChat

Please contact our salesmen for specific payment information.

3.2.F00VC01333 Valve assembly’s Main Sales Market.

Valve assembly main sales markets: Asia, Europe, North America, South America, Africa etc.

3.3.F00VC01333 Valve assembly’s Declaration Requirements

Shumatt can assist customers to provide the following documents for import customs clearance: contract, invoice, packing list, bill of lading, insurance policy, certificate of origin, etc.

3.4.F00VC01333 Valve Assembly’s Shipping Ways

Destination in China areas: SF Express, Debon Express, the corresponding logistics company can be provided according to customer requirements in special cases.

Destinations out of China’s areas: DHL, UPS, FedEx, TNT air, ocean or other shipping methods required by customers.

3.5.F00VC01333 Valve Assembly’s Lead Time

Lead time: Send out within 3 – 7 working days after receiving payment (Except for special products and special cases).

3.6.F00VC01333 Valve Assembly's Logistics Time for Destination Out of China's Areas

DHL Logistics Time:

Country or Region of Departure	Hong Kong, China	Other Countries or Regions of Asia	Australia and New Zealand	Europe	America	Other Countries
China's Mainland	7 Days	7 Days	8 Days	8 Days	8-12 Days	7-10 Days

UPS Logistics Time: Country or Region of Departure: China's Mainland

Country of Destination	Estimated Arrival Time	Country of Destination	Estimated Arrival Time	Country of Destination	Estimated Arrival Time
Japan	3 Days	UK	5-7 Days	Egypt	5-7 Days
Turkey	5-7 Days	Singapore	3 Days	Switzerland	5-7 Days
Bahrain	5-7 Days	Latvia	7-10 Days	New Zealand	7-10 Days
Sri Lanka	5-7 Days	Thailand	3 Days	Austria	5-7 Days
Romania	5-7 Days	Vietnam	3-5 Days	Estonia	5-7 Days
Malaysia	3-5 Days	Israel	5-7 Days	Mexico	7-10 Days
France	5-7 Days	America	5-7 Days	United Arab Emirates	5-7 Days
Italy	5-7 Days	Netherlands	5-7 Days	Bengal	7-10 Days
Lebanon	5-7 Days	Philippine	3-5 Days	Greece	7-10 Days
South Korea	3 Days	Spain	5-7 Days	Myanmar	5-7 Days
Canada	5-7 Days	Germany	5-7 Days	Saudi Arabia	7-10 Days
Portugal	5-7 Days	Australia	5-7 Days	South Africa	7-10 Days
Denmark	5-7 Days	Belgium	5-7 Days	Ukraine	7-10 Days
India	7-10 Days	Qatar	7-10 Days	Poland	5-7 Days
Indonesia	3-5 Days	Morocco	7-10 Days	Pakistan	7-10 Days
Kuwait	7-10 Days				

The logistics time is for reference only, subjects are according to the actual arrival.

3.7.F00VC01333 Valve Assembly's Packing

Domestic express packaging: Usually wrapped in waterproof scotch tape, such as picture No.2.

International express packaging : Wrapped with waterproof yellow tape After wrapping the black protective film, such as picture No. 3.

Pallet Shipping: Use fumigation free and recycling trays that meet export requirements, and use white wrapping protective film to wrap and bind with cable ties for the outside, such as picture No. 4, Also, the products can be packaged according to customers' requirements.

- ⚠ The packing tray is made of plastic and can be recycled.
- ⚠ Transparent tape, yellow tape, black wrapping protective film, white wrapping protective film are non-degradable materials, please dispose of them properly.
- ⚠ Minors are prohibited from using transparent tape, yellow tape, black wrapping protective film, and white wrapping protective film to avoid personal injury.



Pic No.1

Domestic express packaging:
Wrapped by Transparent tape

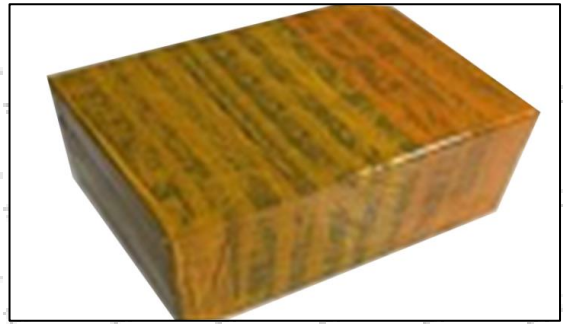

Pic No.2

International express packaging:
Wrapped with yellow tape after wrapping
black protective film



Pic No.3

Pallet Shipping: Use pallet that meet export requirements, and use white wrapping protective film to wrap and bind with cable ties

4.F00VC01333 Valve Assembly's Storage Standard

(1) Choose a suitable storage place

The warehouse and cargo yard where the fuel injector is stored should be kept clean and dry, and away from the factory buildings that generate harmful gases and dust; do not mix with acid, alkali, salt and other substances; the storage place should have a good drainage system; the cargo yard should be flattened with gravel or furnace ash etc. to enhance the water permeability of the surface layer to keep the reservoir area dry.

(2) Strict requirements of warehousing

Strict inspections should be carried out when the fuel injectors are put into storage, the surface cleaning work should be done well to remove water traces, oil stains, ash and other dirt, remove the rust and do anti-rust treatment in time. Packaged injectors must be protected from damage.

(3) Keep the warehouse dry and preventing moisture

The relative humidity is usually below 70% for the fuel injectors placed in the room, and the corrosion of the fuel injectors is significantly reduced.

Injectors must be stored in the warehouse, and they are forbidden to store in the same warehouse with commodities with high water content.

(4) Stack Properly

After the injector is exposed to rain, the corrosion rate will increase significantly. The purpose of sealing

is to isolate the injector from rainwater and humid air, so the warehouse window should be checked in time to avoid rainwater entering the warehouse

If the fuel injector package is damaged, it should be repaired or replaced; when the package is damp, the packaging material should be dried; if the original anti-corrosion and oil applied at the factory is found to be damaged or dried up, it should be cleaned and re-applied oil in time.

It is forbidden to leave the injector exposed in the air for a long time.

It is forbidden to store acid, alkali, salt and other substances together with the injector.

The unpacked fuel injector must be rust-proof during secondary storage.

5. Company Information



Office Locations

Global Exhibitions

5.1. Company Introduction

Chinese Name: 深圳市舒马特科技有限公司

English Name: Shenzhen Shumatt Technology Co., Ltd

Mob Phone/WeChat: +86-13410541523

HK Telephone: +852-67653519

Telephone: +86-755-23215133

Email: ruby@shumatt.com

Website: www.shumatt.net

Shenzhen Office: 11-12, Floor 14, Building 13, Qinchengda Building, Exit A, Honglang North Subway Station, Bao'an District, Shenzhen, China's Mainland

Shenzhen Office: Room 428-430, Building B, Huafeng Zhigu Technology Industrial Park, Exit B, Fuyong Metro Station, Bao'an District, Shenzhen, China's Mainland

Hong Kong Office: Jianfa Street Industrial Zone, Tuen Mun, New Territories, Hong Kong, China

After-sales Service Address: Please contact our salesmen to obtain and provide the corresponding product maintenance reasons (Reference: [1.7.F00VC01333 Injector Valve Assembly's Warranty Instructions](#))

5.2. Sales-men's Contact Information

No.	Name	WeChat/ WhatsApp	Email	Facebook	YouTube
1	Ruby	+86-13410541523	ruby@shumatt.com	Hison Li	Hison Li
2	Ivy	+86-18025309821	sales@shumatt.com	Ivy Shumatt	Shumatt IVY

3	Rebecca	+86-18025349821	sales01@shumatt.com	Rebecca SHUMATT	SHUMATT Rebecca
4	Janny	+86-18028749821	sales02@shumatt.com	Janny shumatt	Janny Shumatt
5	Sam	+86-13316859821	Sales8@shumatt.com	Shumatt Sam	Sam Shumatt
6	Natalie	+86- 18938945856	sales15@shumatt.com	Shumatt Natalie	Lin Natalie
7	Ada	+86-1342286353	sales5@shumatt.com	Shumatt Ada	Ada Shumatt
8	Hison Li	+86-18318811871	web@shumatt.com	Hison Li	Hison Li
9	Mecca	+86-18938948618	sales11@shumatt.com	Shumatt Mecca	Shumatt Mecca
10	Eric	+86 18319033618	sales3@shumatt.com		
11	Wayne (Joaquín en español)	+86-13316959821	wayne@shumatt.com	shumattwayne	Wayne Shumatt
12	Sylvia	+86 18312499884	sales6@shumatt.com		
Visit http://shumatt.com to obtain the latest information of sales-men					
PS: Shumatt's sales-men's emails are all end with @shumatt.com					

6. Copyright Statement

The copyright of any contents “FOOVC01333 valve assembly technical file” (including but not limited to parameters, data, text, charts, images, sounds or videos, etc.) provided in “FOOVC01333 Valve assembly Technical File” belong to Shenzhen Shumatt Technology Co., Ltd. Without the prior written permission of Shenzhen Shumatt Technology Co., Ltd., you are not allowed to modify any contents in “FOOVC01333 Valve assembly Technical File” in any way. At the same time, any conditions to spread, re-post, display the contents of “FOOVC01333 Valve assembly Technical File” should indicate that the cited article is from Shenzhen Shumatt Technology Co., Ltd., Any actions failure to follow above conditions to use “FOOVC01333 Valve assembly Technical File” will violate the "Copyright Law of the People's Republic of China" and other laws and regulations and the provisions of relevant international conventions.